



**DKT2404-DECT  
User Guide**

# Publication Information

**Toshiba America Information Systems, Inc.  
Telecommunication Systems Division**

## **Publication Information**

Toshiba America Information Systems, Inc., Telecommunication Systems Division, reserves the right, without prior notice, to revise this information publication for any reason, including, but not limited to, utilization of new advances in the state of technical arts or to simply change the design of this document.

Further, Toshiba America Information Systems, Inc., Telecommunication Systems Division, also reserves the right, without prior notice, to make such changes in equipment design or components as engineering or manufacturing methods may warrant.

CIX-UG-DKT2404-DECT-VA-E  
Version A2, April 6, 2009

Our mission to publish accurate, complete and user accessible documentation. At the time of printing the information in this document was as accurate and current as was reasonably possible. However, in the time required to print and distribute this manual additions, corrections or other changes may have been made. To view the latest version of this or other documents please refer to the Toshiba FYI web site.

Toshiba America Information Systems shall not be liable for any commercial losses, loss of revenues or profits, loss of goodwill, inconvenience, or exemplary, special, incidental, indirect or consequential damages whatsoever, or claims of third parties, regardless of the form of any claim that may result from the use of this document.

THE SPECIFICATIONS AND INFORMATION PROVIDED HEREIN ARE FOR INFORMATIONAL PURPOSES ONLY AND ARE NOT A WARRANTY OF ACTUAL PERFORMANCE, WHETHER EXPRESSED OR IMPLIED. THE SPECIFICATIONS AND INFORMATION ARE SUBJECT TO CHANGE WITHOUT NOTICE. ACTUAL PERFORMANCE MAY VARY BASED ON INDIVIDUAL CONFIGURATIONS, USE OF COLLATERAL EQUIPMENT, OR OTHER FACTORS.

---

## © Copyright 2009

This document is copyrighted by Toshiba America Information Systems, Inc. with all rights reserved. Under the copyright laws, this document cannot be reproduced in any form or by any means—graphic, electronic, or mechanical, including recording, taping, photocopying, without prior written permission of Toshiba. No patent liability is assumed, however, with respect to the use of the information contained herein.

## Trademarks

Strata and CIX are registered trademarks of Toshiba Corporation.

Stratagy, eManager, My Phone Manager and Info Manager are registered trademarks of Toshiba America Information Systems, Inc.

Windows and Microsoft are registered trademarks of Microsoft.

Trademarks, registered trademarks, and service marks are the property of their respective owners.

---

## **TOSHIBA AMERICA INFORMATION SYSTEMS, INC. (“TAIS”) Telecommunication Systems Division License Agreement**

IMPORTANT: THIS LICENSE AGREEMENT (“AGREEMENT”) IS A LEGAL AGREEMENT BETWEEN YOU (“YOU”) AND TAIS. CAREFULLY READ THIS LICENSE AGREEMENT. USE OF ANY SOFTWARE OR ANY RELATED INFORMATION (COLLECTIVELY, “SOFTWARE”) INSTALLED ON OR SHIPPED WITH A TAIS DIGITAL SOLUTIONS PRODUCT OR OTHERWISE MADE AVAILABLE TO YOU BY TAIS IN WHATEVER FORM OR MEDIA, WILL CONSTITUTE YOUR ACCEPTANCE OF THESE TERMS, UNLESS SEPARATE TERMS ARE PROVIDED BY THE SOFTWARE SUPPLIER. IF YOU DO NOT AGREE WITH THE TERMS OF THIS LICENSE AGREEMENT, DO NOT INSTALL, COPY OR USE THE SOFTWARE AND PROMPTLY RETURN IT TO THE LOCATION FROM WHICH YOU OBTAINED IT IN ACCORDANCE WITH APPLICABLE RETURN POLICIES. EXCEPT AS OTHERWISE AUTHORIZED IN WRITING BY TAIS, THIS SOFTWARE IS LICENSED FOR DISTRIBUTION THROUGH TAIS AUTHORIZED CHANNELS ONLY TO END-USERS PURSUANT TO THIS LICENSE AGREEMENT.

1. License Grant. The Software is not sold; it is licensed upon payment of applicable charges. TAIS grants to you a personal, non-transferable and non-exclusive right to use the copy of the Software provided under this License Agreement. You agree you will not copy the Software except as necessary to use it on one TAIS system at a time at one location. Modifying, translating, renting, copying, distributing, printing, sublicensing, transferring or assigning all or part of the Software, or any rights granted hereunder, to any other persons and removing any proprietary notices, labels or marks from the Software is strictly prohibited except as permitted by applicable law; you agree violation of such restrictions will cause irreparable harm to TAIS and provide grounds for injunctive relief, without notice, against you or any other person in possession of the Software. You and any other person whose possession of the software violates this License Agreement shall promptly surrender possession of the Software to TAIS, upon demand. Furthermore, you hereby agree not to create derivative works based on the Software. TAIS reserves the right to terminate this license and to immediately repossess the software in the event that you or any other person violates this License Agreement. Execution of the Software for any additional capabilities require a valid run-time license.
2. Intellectual Property. You acknowledge that no title to the intellectual property in the Software is transferred to you. You further acknowledge that title and full ownership rights to the Software will remain the exclusive property of TAIS and/or its suppliers, and you will not acquire any rights to the Software, except the license expressly set forth above. You will not remove or change any proprietary notices contained in or on the Software. The Software is protected under US patent, copyright, trade secret, and/or other proprietary laws, as well as international treaties. Any transfer, use, or copying of the software in violation of the License Agreement constitutes copyright infringement. You are hereby on notice that any transfer, use, or copying of the Software in violation of this License Agreement constitutes a willful infringement of copyright.
3. No Reverse Engineering. You agree that you will not attempt, and if you employ employees or engage contractors, you will use your best efforts to prevent your employees and contractors from attempting to reverse compile, reverse engineer, modify, translate or disassemble the Software in whole or in part. Any failure to comply with the above or any other terms and conditions contained herein will result in the automatic termination of this license and the reversion of the rights granted hereunder back to TAIS.
4. Limited Warranty. THE SOFTWARE IS PROVIDED ‘AS IS’ WITHOUT WARRANTY OF ANY KIND, TO THE MAXIMUM EXTENT PERMITTED BY APPLICABLE LAW, TAIS AND ITS SUPPLIERS DISCLAIM ALL WARRANTIES WITH REGARD TO THE SOFTWARE, EITHER EXPRESS OR IMPLIED, INCLUDING, BUT NOT LIMITED TO, THE WARRANTY OF NON-INFRINGEMENT OF THIRD PARTY RIGHTS, THE WARRANTY OF YEAR 2000 COMPLIANCE, AND THE IMPLIED WARRANTIES OF MERCHANTABILITY AND FITNESS FOR A PARTICULAR PURPOSE. THE ENTIRE RISK AS TO THE QUALITY AND PERFORMANCE OF THE SOFTWARE IS WITH YOU. NEITHER TAIS NOR ITS SUPPLIERS WARRANT THAT THE FUNCTIONS CONTAINED IN THE SOFTWARE WILL MEET YOUR REQUIREMENTS OR THAT THE OPERATION OF THE SOFTWARE WILL BE UNINTERRUPTED OR ERROR-FREE. HOWEVER, TAIS WARRANTS THAT ANY MEDIA ON WHICH THE SOFTWARE IS FURNISHED IS FREE FROM DEFECTS IN MATERIAL AND WORKMANSHIP UNDER NORMAL USE FOR A PERIOD OF NINETY (90) DAYS FROM THE DATE OF DELIVERY TO YOU.
5. Limitation of Liability. TAIS’ ENTIRE LIABILITY AND YOUR SOLE AND EXCLUSIVE REMEDY UNDER THIS LICENSE AGREEMENT SHALL BE AT TAIS’ OPTION REPLACEMENT OF THE MEDIA OR REFUND OF THE PRICE PAID, TO THE MAXIMUM EXTENT PERMITTED BY APPLICABLE LAW, IN NO EVENT SHALL TAIS OR ITS SUPPLIERS BE LIABLE TO YOU FOR ANY CONSEQUENTIAL, SPECIAL, INCIDENTAL OR INDIRECT DAMAGES FOR PERSONAL INJURY, LOSS OF BUSINESS PROFITS, BUSINESS INTERRUPTION, LOSS OF BUSINESS INFORMATION/DATA, OR ANY OTHER PECUNIARY LOSS OF ANY KIND ARISING OUT OF THE USE OR INABILITY TO USE THE SOFTWARE, EVEN IF TAIS OR ITS SUPPLIER HAS BEEN ADVISED OF THE POSSIBILITY OF SUCH DAMAGES. IN NO EVENT SHALL TAIS OR ITS SUPPLIERS BE LIABLE FOR ANY CLAIM BY A THIRD PARTY.
6. State/Jurisdiction Laws. SOME STATES/JURISDICTIONS DO NOT ALLOW THE EXCLUSION OF IMPLIED WARRANTIES OR LIMITATIONS ON HOW LONG AN IMPLIED WARRANTY MAY LAST, OR THE EXCLUSION OR LIMITATION OF INCIDENTAL OR CONSEQUENTIAL DAMAGES. SO SUCH LIMITATIONS OR EXCLUSIONS MAY NOT APPLY TO YOU. THIS LIMITED WARRANTY GIVES YOU SPECIFIC RIGHTS AND YOU MAY ALSO HAVE OTHER RIGHTS WHICH VARY FROM STATE/JURISDICTION TO STATE/JURISDICTION.
7. Export Laws. This License Agreement involves products and/or technical data that may be controlled under the United States Export Administration Regulations and may be subject to the approval of the United States Department of Commerce prior to export. Any export, directly or indirectly, in contravention of the United States Export Administration Regulations, or any other applicable law, regulation or order, is prohibited.
8. Governing Law. This License Agreement will be governed by the laws of the State of California, United States of America, excluding its conflict of law provisions.
9. United States Government Restricted Rights. The Software is provided with Restricted Rights. The Software and other materials provided hereunder constitute Commercial Computer Software and Software Documentation and Technical Data related to Commercial Items. Consistent with F.A.R. 12.211 and 12.212 they are licensed to the U.S. Government under, and the U.S. Government’s rights therein are restricted pursuant to, the vendor’s commercial license.
10. Severability. If any provision of this License Agreement shall be held to be invalid, illegal or unenforceable, the validity, legality and enforceability of the remaining provisions hereof shall not in any way be affected or impaired.
11. No Waiver. No waiver of any breach of any provision of this License Agreement shall constitute a waiver of any prior, concurrent or subsequent breach of the same or any other provisions hereof, and no waiver shall be effective unless made in writing and signed by an authorized representative of the waiving party.
12. Supplier Software. The Software may include certain software provided by TAIS suppliers. In such event, you agree that such supplier may be designated by TAIS as a third party beneficiary of TAIS with rights to enforce the Agreement with respect to supplier’s software.

YOU ACKNOWLEDGE THAT YOU HAVE READ THIS LICENSE AGREEMENT AND THAT YOU UNDERSTAND ITS PROVISIONS. YOU AGREE TO BE BOUND BY ITS TERMS AND CONDITIONS. YOU FURTHER AGREE THAT THIS LICENSE AGREEMENT CONTAINS THE COMPLETE AND EXCLUSIVE AGREEMENT BETWEEN YOU AND TAIS AND SUPERSEDES ANY PROPOSAL OR PRIOR AGREEMENT, ORAL OR WRITTEN, OR ANY OTHER COMMUNICATION RELATING TO THE SUBJECT MATTER OF THIS LICENSE AGREEMENT.

**Toshiba America Information Systems, Inc.  
Telecommunication Systems Division  
9740 Irvine Boulevard  
Irvine, California 92618-1697  
United States of America**

5932

# **Toshiba America Information Systems, Inc. Telecommunication Systems Division**

## **Limited Warranty**

Toshiba America Information Systems, Inc., ("TAIS") warrants that:

- The CIX Attendant Console equipment, such as the PC (except for fuses, lamps, and other consumables) will, upon delivery by TAIS or an authorized TAIS dealer to a retail customer in new condition, be free from defects in material and workmanship for twelve (12) months after delivery.
- And that the Toshiba telephone equipment (except for fuses, lamps, and other consumables) will, upon delivery by TAIS or an authorized TAIS dealer to a retail customer in new condition, be free from defects in material and workmanship for twenty-four (24) months after delivery.

This warranty is void (a) if the equipment is used under other than normal use and maintenance conditions, (b) if the equipment is modified or altered, unless the modification or alteration is expressly authorized by TAIS, (c) if the equipment is subject to abuse, neglect, lightning, electrical fault, or accident, (d) if the equipment is repaired by someone other than TAIS or an authorized TAIS dealer, (e) if the equipment's serial number is defaced or missing, or (f) if the equipment is installed or used in combination or in assembly with products not supplied by TAIS and which are not compatible or are of inferior quality, design, or performance.

The sole obligation of TAIS or Toshiba Corporation under this warranty, or under any other legal obligation with respect to the equipment, is the repair or replacement by TAIS or its authorized dealer of such defective or missing parts as are causing the malfunction with new or refurbished parts (at their option). If TAIS or one of its authorized dealers does not replace or repair such parts, the retail customer's sole remedy will be a refund of the price charged by TAIS to its dealers for such parts as are proven to be defective, and which are returned to TAIS through one of its authorized dealers within the warranty period and no later than thirty (30) days after such malfunction, whichever first occurs.

Under no circumstances will the retail customer or any user or dealer or other person be entitled to any direct, special, indirect, consequential, or exemplary damages, for breach of contract, tort, or otherwise. Under no circumstances will any such person be entitled to any sum greater than the purchase price paid for the item of equipment that is malfunctioning.

To obtain service under this warranty, the retail customer must bring the malfunction of the machine to the attention of one of TAIS' authorized dealers within the twenty-four (24) month period and no later than thirty (30) days after such malfunction, whichever first occurs. Failure to bring the malfunction to the attention of an authorized TAIS dealer within the prescribed time results in the customer being not entitled to warranty service.

**THERE ARE NO OTHER WARRANTIES FROM EITHER TOSHIBA AMERICA INFORMATION SYSTEMS, INC., OR TOSHIBA CORPORATION WHICH EXTEND BEYOND THE FACE OF THIS WARRANTY. ALL OTHER WARRANTIES, EXPRESS OR IMPLIED, INCLUDING THE WARRANTIES OF MERCHANTABILITY, FITNESS FOR A PARTICULAR PURPOSE, AND FITNESS FOR USE, ARE EXCLUDED.**

No TAIS dealer and no person other than an officer of TAIS may extend or modify this warranty. No such modification or extension is effective unless it is in writing and signed by the vice president and general manager, Telecommunication Systems Division.

# **WARRANTIES FOR NON-TOSHIBA BRANDED THIRD PARTY PRODUCTS**

A valuable element of Toshiba's product strategy is to offer our customers a complete product portfolio. To provide this value to our customers at the most optimal prices, we offer both Toshiba-branded and third-party manufactured products that support our Toshiba Strata CIX product portfolio. Similar to other resellers of software, hardware and peripherals, these third-party manufactured products carry warranties independent of our Toshiba limited warranty provided with our Toshiba-branded products. Customers should note that third-party manufacturer warranties vary from product to product and are covered by the warranties provided through the original manufacturer and passed on intact to the purchaser by Toshiba. Customers should consult their product documentation for third-party warranty information specific to third-party products. More information may also be available in some cases from the manufacturer's public website.

While Toshiba offers a wide selection of software, hardware and peripheral products, we do not specifically test or guarantee that the third-party products we offer work under every configuration with any or all of the various models of the Toshiba Strata CIX. Toshiba does not endorse, warrant nor assume any liability in connection with such third party products or services. If you have questions about compatibility, we recommend and encourage you to contact the third-party software, hardware and peripheral product manufacturer directly.

# Contents

---

## Chapter 1 – STRATA DKT2404-DECT

Technology .....	3
Benefits .....	3
Handset .....	4
LCD Display .....	6
Base Station .....	6
Charging Unit .....	6
Cordless Digital Telephone Standard Parts .....	7

## Chapter 2 – Installation

Base Unit .....	14
Charging Unit .....	14
Standard Wall Plate Mounting .....	15
Direct Wall Mounting .....	16
Charging Unit Wall Mounting .....	17

## Chapter 3 – Operation & Setup

Power Up .....	21
Power Down .....	21
Operation with the Strata CIX .....	21
Making a Call to Another Extension .....	22
Receiving a Call from Another Extension .....	23
Making an Outside Call .....	24
Receiving an Outside Call .....	24
Finish Talk Mode .....	25
Redial (Option) .....	25
Channel Change .....	25

## Contents

### Chapter 4 – Feature Access Codes

CIX No Service .....	25
Out of Range .....	26
Low Battery.....	27
Mute.....	27
Hands Free .....	28
Volume Setting .....	28
Ring Volume Setting.....	28
Ringer Mute .....	29
Menu Setting Mode.....	30
Change Ringer Type .....	30
End of Range Alarm .....	31
Registration .....	32
Deregistration .....	33
Base Registration PIN .....	34
Base Key Option (Option).....	34
One Touch Dialing .....	35
Dial Store Mode.....	35
Dial Out.....	37
F9~F12 Feature Buttons.....	37
Place a Call on Hold .....	37
Transfer a Call .....	37
Redial a Number.....	38
Conference a Call .....	38
Switch a Call to Your Cordless Digital Telephone .....	38
Switch a Call to the Desk Telephone.....	38

### Chapter 4 – Feature Access Codes

Feature Access Codes .....	39
Call Forward Codes .....	43

### Chapter 5 – Troubleshooting and Specifications

Troubleshooting .....	47
DKT Mode.....	48
Cleaning Charging Unit Contacts .....	48
Charging Spare Battery Packs .....	49
Range and Performance.....	49
Radio Interference .....	49

Telephone Line Problems .....50  
Privacy .....50  
Specifications.....51

This page intentionally left blank.

# STRATA DKT2404-DECT

# 1

Your DKT2404-DECT delivers next generation DECT functionality for the Strata series of cordless digital telephones. DECT technology minimizes any interference between base stations in proximity or any surrounding WLAN access points. It is also engineered to work with your Toshiba digital telephone system and provide you with reliability, long life, and outstanding performance.



The DKT2404-DECT is compatible with all Strata CIX and CTX systems (Release 2 and later). All it requires for connection is a digital station port.

**Note** System software release 2 or 3, or connection to a PDKU card will limit the DKT2404-DECT display to 16 characters.

The 2404-DECT telephone base station has a range of up to 300 ~400 feet. Combined with the optional DKT2404-UDR100 Repeater, the new DECT technology provides wide range operation. Up to six repeaters can be linked per base station, extending operation range up to greater than 1000 feet in open areas. Refer to [“Range and Performance”](#) on [page 49](#).

Fully charged, the DKT2404-DECT provides 16 hours of talk time and 7 days standby time.

You can use your cordless as a stand-alone phone attached to a digital port, or in conjunction with a DP/DKT-series digital telephone—in which case both phones share the same digital port and extension number. You can switch between use of your DP/DKT and your cordless, by just pressing a button.

**Note** If using a DP5000 or DKT3000 digital telephone, the telephone must be set to operate in DKT2000 mode. If the mode is not set to DKT2000, the desk telephone will not operate correctly.

Some of its features are:

- Two-line LCD with 24 character display, plus one line for icons



- Ringer and handset volume control (or vibrate)
- Single button access to: Conference/Transfer, Hold, Redial, Message, Talk, Menu/Mute, Speaker
- Four programmable function buttons plus four speed dial buttons
- Charging stand (with spare battery charging capability)
- Wall-mountable base and charging units
- Headset jack (2.5mm)
- Three ring tones
- Hands free speakerphone operation
- Repeater option for extended range (optional Repeater Programming Kit for daisy-chaining Repeaters)
- High quality ultra-secure speech with 32Kbps Adaptive Differential Pulse Code Modulation (ADPCM) voice code combination.

# Technology

Your DKT2404-DECT uses DECT 6.0 1.9 GHz technology, which represents state-of-the-art design and engineering. This technology provides:

- Unsurpassed range, several times greater than conventional analog or cordless digital telephones.
- Clarity that is so good it is practically indistinguishable from corded telephones in most environments.
- Fully secure communications within a given environment.

# Benefits

Your DKT2404-DECT uses advanced technology and provides important features placing it far above the competition in functionality and value by giving you better sound quality, longer range, greater security, multi-line access, helpful LCD display information, and many other important advantages.

Other benefits are:

- Four programmable feature buttons. If you do not use these buttons for the assigned features, you can invoke other features with access codes.
- Your DKT2404-DECT rings to the same extension number as the regular DKT it is used with, enabling you to answer via either telephone. Both follow the same forwarding and hunting regardless of which telephone is in use. This is much simpler than having a separate extension number and standard station port for a conventional single-line cordless telephone.
- A Message Waiting icon  appears on the LCD when message(s) are in the user's mailbox.

In addition to the benefits mentioned above, the DKT2404-DECT also has the following benefits:

- Spread-spectrum technology provides much greater range than conventional cordless telephones.
- DECT 6.0 1.9 GHz operation provides security that is extremely difficult to scan.

# Handset

The DKT2404-DECT cordless handset has special function buttons and an LCD that shows operating conditions. A setting example is shown below.

**Note** The handset and base unit of your cordless telephone is equipped with the same security code. In order for this handset to operate, it must be installed with the matching base unit.

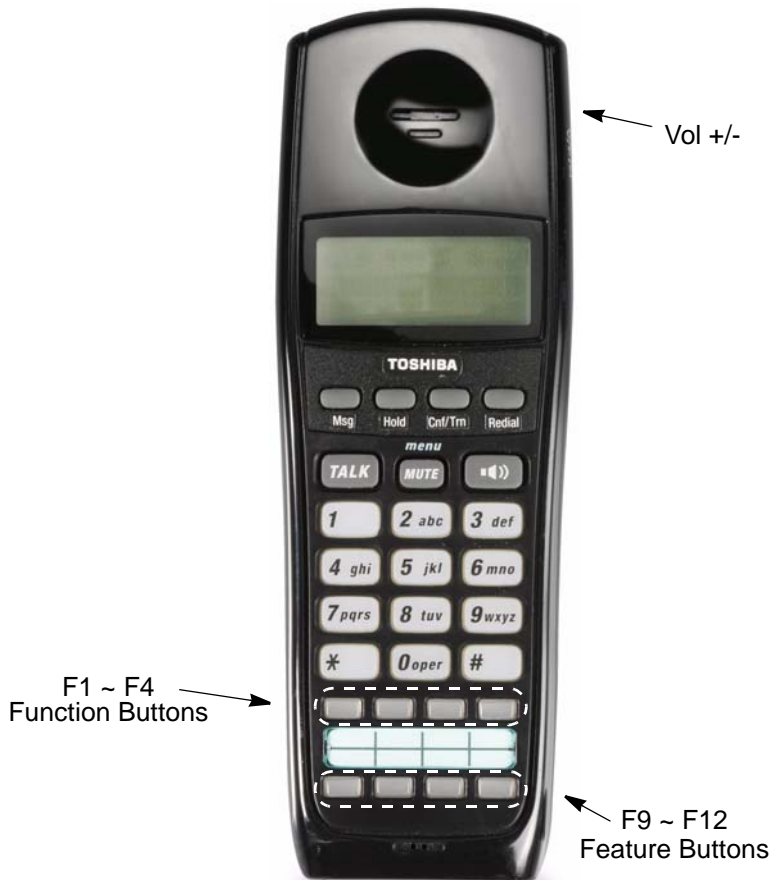









Table 1. DKT2404-DECT Handset LCD Icons

Button	Description
+/-	Selects ringer volume in standby mode and speaker volume in talk mode.
	Handset talk mode
	With slash Mute is on Without slash Mute is off
	Hands-free icon - Hands-free talk or ear speaker talk
	Shows when message(s) exist; off when there are no messages.
	With slash - ringer is muted Without slash - ringer will sound
	Battery Full - indicator is 3 Battery Level 2 - indicator is 2 Battery Level 1 - indicator is 1 Battery Low - blinking indicator Charge On - Charge Indicator as Low > Level 1 > Level 2 > Full > Low When the handset is on the charger with the battery at full, the battery status icon shows battery full.

## LCD Display

The LCD display consists of two lines of 24 characters each and six icons—Talk, Mute, Speaker, Message Waiting , Ringer Off and Battery.

## Base Station

The base station can be used on a surface or wall-mounted unit. SW1 is located to the left of the power LED is used for registration and test purposes only. The LED is on when the base unit is powered on and blinks when the base unit is in registration mode.

**Note** The handset and base unit of the DKT2404-DECT are equipped with the same security code. For the base unit to operate, it must be installed with the matching handset.

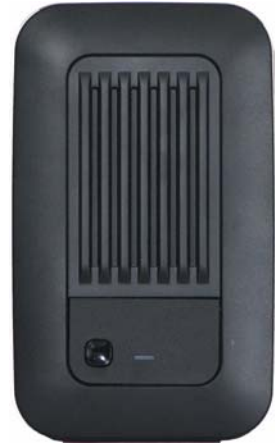

## Charging Unit

The handset comes with a charging unit (shown at right), which can be wall-mounted or not, and has two slots. The front slot functions as a cradle for the handset when idle and a charger for the handset battery.

The rear slot is for spare battery charging. It automatically discharges when it detects that discharging is necessary.

**LEDs - handset** and **battery** indicate battery charging status. The LEDs are red when charging, and are off when not charging.



# **Cordless Digital Telephone Standard Parts**

Your Toshiba cordless digital telephone includes the following items:

- Base unit
- Base unit stand
- Base unit wall plate adapter
- Handset
- Rechargeable handset battery
- Charging unit
- Two AC adapters
- Belt clip

If any of these items are missing or damaged, contact your System Administrator.

This page intentionally left blank.

## Step 1: Review Safety Instructions

---

**WARNING!** Toshiba DOES NOT intend this unit to be waterproof. To reduce the risk of fire, electrical shock, or damage to the unit, DO NOT expose this unit to rain or moisture.

---

- Read and understand all product instructions.
- Follow all warnings and instructions marked on the product.
- Cleaning precautions:
  - Disconnect from power source before cleaning.
  - Do not use liquid cleaners or aerosol cleaners.
  - Use a dry cloth for cleaning.
- Do not use this product near water; for example, near a sink, or in any wet area.
- Do not place this product on an unstable cart, stand, or table. The telephone could fall, causing serious damage to the unit.
- To protect the product from overheating, do not:
  - Block or cover any slots or openings in the base unit.
  - Place near or over a radiator or heat register.
  - Place in an enclosed cabinet unless proper ventilation is provided.
- Operate this product only from the type of power source indicated on the marking label.

## Installation

### Step 1: Review Safety Instructions

- Never push objects of any kind into the base unit slots, as the objects could touch dangerous voltage points or short out parts that could cause fire or electric shock.
- To reduce the risk of electric shock, do not disassemble this product. Opening or removing covers could expose you to dangerous voltages or other risks. Incorrect re-assembly can cause electric shock when the appliance is subsequently used. Contact qualified service personnel when service or repair work is required.
- Unplug this product from the wall outlet and refer servicing to qualified service personnel under the following conditions:
  - When the power supply cord is damaged or frayed.
  - If liquid has been spilled into the product.
  - If the product has been exposed to rain or water.
  - If the product does not operate normally when following the operating instructions. Adjust only those controls that are covered by the operating instructions. Improper adjustment of other controls may result in damage, and will often require extensive work by a qualified technician to restore the product to normal operation.
  - If the product has been dropped, or the cabinet has been damaged.
  - If the product exhibits a distinct change in performance.
- Do not use the telephone to report a gas leak in the vicinity of the leak.

---

**WARNING!** Do not attempt to install or unplug this or any device or appliance during an electrical storm.

---

---

**CAUTION!** Changes or modifications to this product not expressly approved by Toshiba, or operation of this product in any way other than as detailed by this User Guide, could void your authority to operate this product.

---

---

**WARNING!**

- **Use only battery model BT-1009. Use of any other battery could cause a safety hazard.**
  - **Do not dispose of the battery in a fire. The cell will explode. Under federal, state and local laws, it could be illegal to dispose of old batteries by placing them in the trash. Check with your local government for information on where to recycle or dispose of old batteries. If you cannot find the information you need, contact Toshiba for assistance.**
  - **Do not remove or damage the battery casing.**
  - **Do not short circuit the battery. Exercise care in handling the battery in order not to short the battery with rings, bracelets, and keys or other conductive materials. The battery or conductor could overheat and cause burns.**
  - **Charge the battery only in accordance with the instructions and limitations specified in the instruction manual provided for this product.**
  - **Do not charge the rechargeable battery in any charger other than the one designed to charge it as specified in this user guide. Using another charger may damage the battery, or cause the battery to explode.**
  - **Observe proper polarity orientation between the battery and charging unit.**
-

## Step 2: Select Location

1. Select a location that is not subject to excessive heat or humidity. Keep the base unit and handset away from sources of electrical noise, such as motors and fluorescent lighting.
2. Determine if the base unit will sit on your desk or be wall mounted. If wall mounted, go to [Step 6: "Wall Installation \(Optional\)"](#).
3. Place the base unit on a desk or tabletop near a standard 120VAC outlet and within reach of the Strata CIX digital line connection.

**Important!** Place the base unit to the right of the DKT. If placed on the left, the cordless antenna picks up a tone due to its close proximity to the DKT speaker and electronic parts.

## Step 3: Place DP/DKT-series Telephones into 2000-Mode

You must place your DP/DKT-series telephone into 2000-mode before connecting the cordless telephone; otherwise, the telephone will not work.

In 2000-mode, the DKT3000 telephone operation changes are:

- Only 16 characters by two lines display on the LCD.
- LCD Feature button does not work
- **Spdial** button does not work

### ► To change DKT3000-series telephones into 2000-mode

1. On the DKT3000 telephone, press **3+6+9+Hold** (simultaneously).
2. Press **#**.
3. Press **FB7** (or **FB10** on the DKT3014). LED On = 2000 mode. LED Off = 3000 mode.

**Note** Flexible Buttons (FB) are numbered from the bottom up and left to right. **FB7** for example would be the seventh button on the left.

4. Press **Hold**.
5. Lift the handset to exit programming mode. Wait a few seconds for the telephone to reset itself.

## Step 4: Connect Telephone Cables

Your cordless telephone must be connected to a Strata CIX digital line port.

---

**WARNING!** Never install telephone wiring during a lightning storm.

---

➤ **To connect as a stand-alone telephone**

- Connect the modular jack labeled “Line In” directly to the telephone wall jack using one of the supplied cables (shown at right).

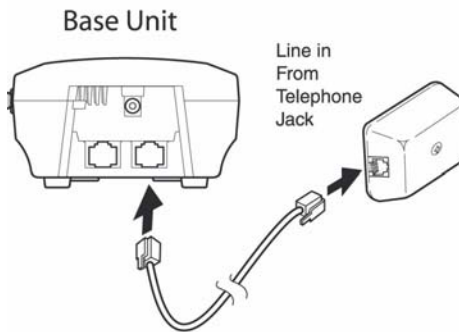

➤ **To connect to a Strata DP/DKT**

1. Unplug the cable from the DP/DKT and plug into the “Line In” jack of cordless telephone base unit (shown at right).
2. Plug the additional two-foot cable into the “Line Out” jack of the base unit and into the DP/DKT jack located on the bottom of the telephone.

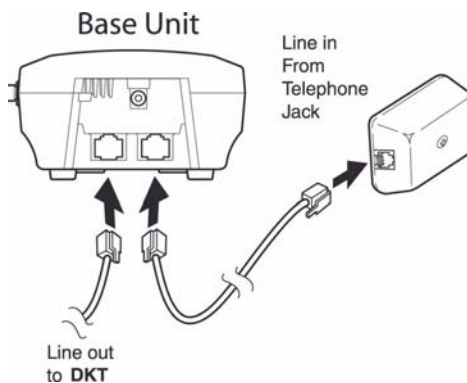

## Installation

### Step 5: Connect and Apply Power

# Step 5: Connect and Apply Power

## Base Unit

1. Plug the AC adapter cord into the AC adapter input jack on the base unit (shown at right).
2. Plug the AC adapter into a standard 120VAC wall outlet.
3. Check to see that the power LED is lit.



## Charging Unit

1. Plug the AC adapter cord into the input jack on the charging unit.
2. Plug the AC adapter into a standard 120VAC wall outlet.
3. Check to see that the **handset** LED is lit.

**Note** You can place the handset in the charging unit with or without the belt clip attached.

### Important!

- Use only the supplied AC adapter.
- If the **handset** LED on the charging unit and/or the **battery** LED on the base unit do not light, return everything to your Authorized Dealer.

## Step 6: Wall Installation (Optional)

**Important!** You must place your DP/DKT-series telephone into 2000-mode before connecting the cordless telephone; otherwise, the DP/DKT-series telephone will not work. See “[Step 3: “Place DP/DKT-series Telephones into 2000-Mode”](#)”.

### Standard Wall Plate Mounting

These telephones are designed to be mounted on a standard wall plate. To attach the wall mount stand to the base unit:

1. Select a wall location near a 120VAC outlet and within reach of the Strata CIX digital line connection.
2. Slide the wall mount stand into the notches at the top of the base unit, push the wall mount stand down and snap it into place (shown right).
3. Plug the AC adapter into the base unit.
4. Place the AC adapter cord inside the molded channel of the wall mount stand.
5. Plug one end of the telephone cord into the LINE jack on the base unit. Optionally, plug one end of a Strata DP/DKT telephone into the PHONE jack. Then place the telephone cord(s) inside the molded channel(s) on the bottom of the wall mount stand.
6. Plug the other end of the telephone cord into the modular wall jack.
7. Place the base unit on the posts of the wall plate and push down until it's firmly seated (shown right).
8. Plug the AC adapter into a standard 120VAC wall outlet.

**Note** Do not use an outlet controlled by a wall switch.

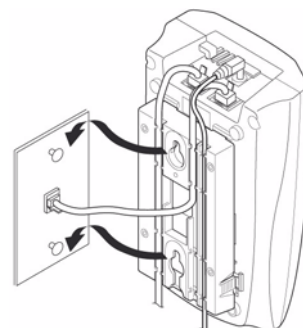
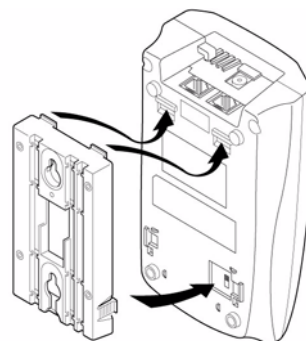

## Installation

### Step 6: Wall Installation (Optional)

## Direct Wall Mounting

If you do not have a standard wall plate, you can mount your telephone directly on a wall. Before mounting your telephone, consider the following:

- Select a location away from electrical cables, pipes, or other items behind the mounting location that could cause a hazard when inserting screws into the wall.
- Make sure the wall material is capable of supporting the weight of the base unit.
- Use #10 screws with anchoring devices suitable for the wall.

### ► To wall mount the base unit

1. Insert two mounting screws 3-15/16 inches apart. Allow about 3/16 of an inch between the wall and screw heads for mounting the telephone (shown right).
2. Plug and secure the AC adapter cord by following Steps 2 and 3 of the “Standard Wall Plate Mounting” on page 15.
3. Plug one end of the telephone line cord into the LINE jack on the base unit. Optionally, plug one end of a Strata DKT telephone into the PHONE jack. Then place the telephone cord(s) inside the molded channel(s) on the bottom of the wall mount stand.
4. Place the base unit on the posts of the wall screws and push down until it's firmly seated.
5. Plug the other end of the telephone cord into a telephone wall jack.
6. Plug the AC adapter into a standard 120VAC wall outlet by following Step 7 of the Standard Wall Plate Mounting.

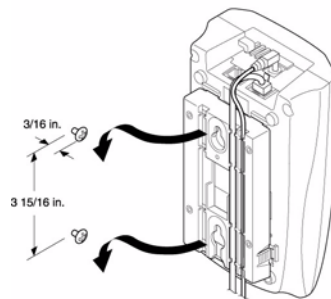
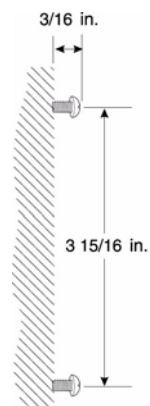

## Charging Unit Wall Mounting

The charging unit is also designed to be wall mounted. Before mounting your charging unit, consider the following:

- Select a location away from electrical cables, pipes, or other items behind the mounting location that could cause a hazard when inserting screws into the wall.
- Make sure the wall material is capable of supporting the weight of the charging unit.
- Use #10 screws with anchoring devices suitable for the wall material where the charging unit will be placed.

1. Insert two mounting screws 2 inches apart. Allow about  $\frac{3}{16}$  of an inch between the wall and screw heads for mounting the telephone.

2. Plug the AC adapter into the charging unit as previously described. Wrap the AC adapter cord around the strain relief (shown right).

3. Place the charging unit on the posts of the wall screws and push down until it is firmly seated (shown right).

4. Plug the AC adapter into a standard 120VAC wall outlet.

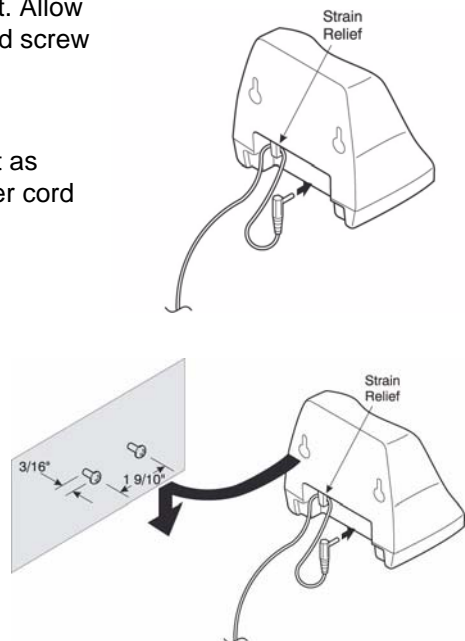

## Installation

### Step 7: Install Handset Battery Pack

# Step 7: Install Handset Battery Pack

1. Remove the battery cover by pressing the latch and sliding the cover down and off the handset.
2. Slide the battery pack down into the handset (shown right) making sure the connectors on the battery and handset meet.
3. Securely close the battery compartment cover by sliding it up until it snaps into place.
4. Securely close the battery compartment cover by sliding it up until it snaps into place.

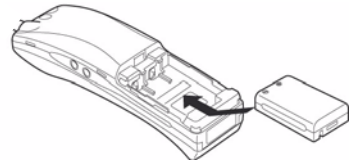

---

**CAUTION!** Rechargeable Nickel-Metal-Hydride batteries must be disposed of properly.

---

# Step 8: Charge Batteries for First Time

**Important!** Before using your DKT2404-DECT, the battery must be continuously charged without interruption for 15 -20 hours. Either the handset or the charging unit can be used.

1. Place the handset in the charging unit.
2. Ensure that the **handset** LED lights. If it does not, make sure that the AC adapter is plugged in and that the handset is making good contact with the charging unit contacts.



## Step 9: Install Headset (Optional)

The optional headset provides hands-free option. With the headset installed, you can use the belt clip to carry the handset and conduct a conversation. All feature operations remain the same except the handset earphone and microphone are disconnected.

- Open the cover over the headset jack that is located on the top of the handset and plug in the headset as shown at right.

**Important!** Only use headsets especially designed or modified for use with radio frequency equipment.



## Step 10: Attach Belt Clip (Optional)

**Note** The belt clip is designed to fit snugly onto the handset.

1. Snap the tab out of the belt clip notch on the top of the handset.
  2. Slide the belt clip into the space where the belt clip tab was, carefully aligning the belt clip sides to the notches.
  3. Press firmly until it snaps into place.
  4. Use the belt clip to attach the handset to your belt or pocket.
- **To remove the belt clip**
    1. Carefully pry the tabs loose and remove the belt clip.
    2. Reinstall the cover tab.

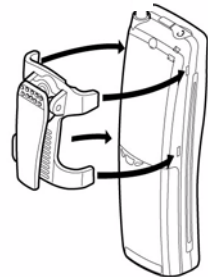

This page intentionally left blank.

## Power Up

- Handset - When the battery is put into the handset it starts operation. Upon power-up the handset searches for RF communication from the base station.
- Base Station - The base station starts operation when the AC adapter is plugged in (there is no On/Off switch).

## Power Down

- Handset - If the handset loses battery or the battery level is less than a threshold set in the handset software, it goes to power-down mode and no talk function is supported.
- Base Station - If the base station loses power no talk function is supported.

## Operation with the Strata CIX

The operation described below is an example of using the DKT2404-DECT with a Strata CIX telephone system and may differ from your particular installation (details depend on your Strata CIX configuration).

## Making a Call to Another Extension

1. Press the **TALK** button or the **speaker-icon** button on the handset. The handset blinks ACQUIRING LINK on the handset LCD and dial tone is heard.

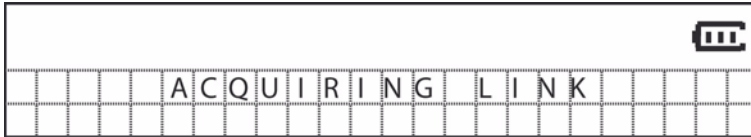

During this time the current volume is displayed for two seconds.

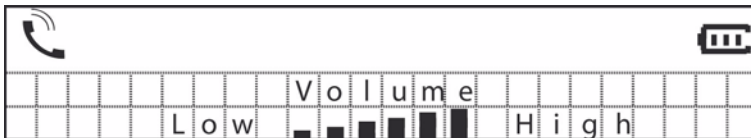

2. Enter the number of the desired party (102), for instance. The LCD shows the dialed numbers and rings the extension.

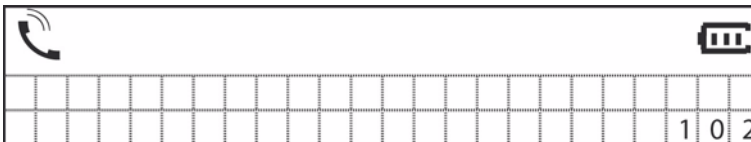

3. When the called party answers, the LCD shows successful connection by displaying the handset icon as shown.

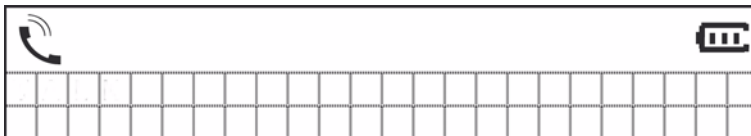

If you walk out of range of the base station, the handset emits an error tone and Out of Range is displayed as shown for five seconds. The handset then goes into idle mode.

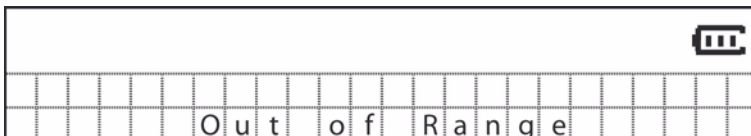

## Receiving a Call from Another Extension

1. When you receive a call from another extension the handset rings a tone and shows the information of the calling party (e.g., name and ext. number in place of the INCOMING CALL display) on the LCD.

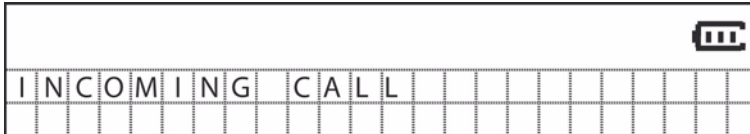

2. Press **TALK** or any of the dialing buttons, or if the handset is in the charger, just pick it up. The handset connects to the base station and *may* show the following message (depends on how quickly the RF connection is established):

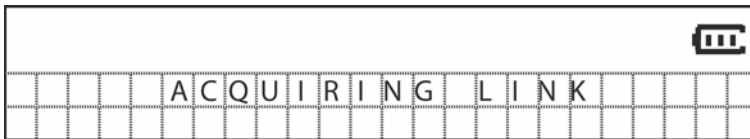

3. The current volume shows for two seconds, then the talk screen displays.

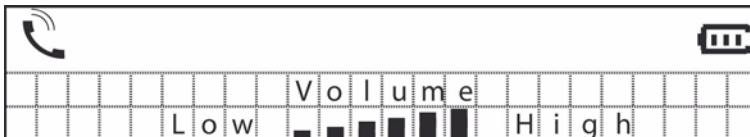

The talk screen displays the calling party information for the duration of the call.

### Making an Outside Call

1. Press the outside line button (usually the F1 button). The handset connects to the base station, Receives the enable command from the Strata CIX and goes into talk mode - the line button lights, the current volume shows for two seconds and dial tone is heard.

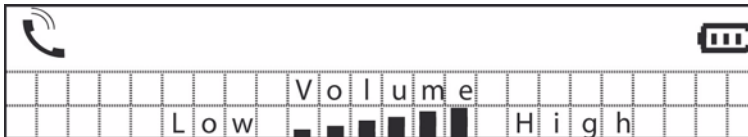

2. Any entered digits show in the LCD.

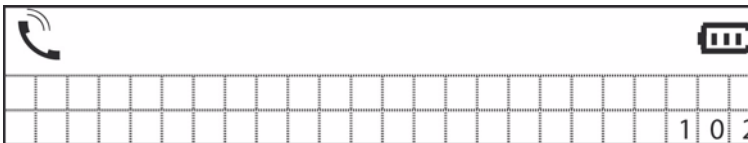

### Receiving an Outside Call

1. Dependent upon the Strata CIX settings, when an outside call comes in the handset goes into incoming call mode, ringing a tone and indicating the call on the LCD.

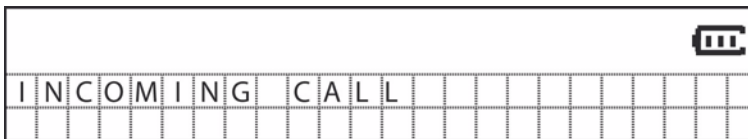

2. Press one of the following:
  - the blinking outside line button (dependent on the Strata CIX)
  - the **TALK** button
  - any dialing button
  - or just pick up the handset if it is in the charger.
3. The current volume shows for two seconds, then the talk screen displays.

## Finish Talk Mode

When your call is complete, end the connection by pressing the **TALK** button on the handset, or just place the handset on the charger.

## Redial (Option)

If the Redial option is enabled, the Redial (F8 button) is used to invoke the operation. Press the **TALK** or the **speaker-icon** button to get dial tone and then press the **Redial** button. The last number dialed is shown in the LCD and the number is sent to the Strata CIX for processing.

Redial digit length can be up to 32 digits. If, after talk mode is established, F8 is the first button pressed, it acts as redial; in other cases, F8 operation is ignored (see example below):

<Example>

- (1) [talk][1][2][3][talk] redial: 123
- (2) [talk][1][2][3].....[1][2][talk] (over 32digits) redial: 123.....12 (up to 32digits)
- (3) [talk][1][2][3][F1][4][5][6][talk] redial: 123

## Channel Change

Channel change occurs automatically.

## CIX No Service

In cases when the **TALK** or **speaker-icon** button is pushed and connection to the CIX cannot be established, or if the base station doesn't respond, the handset goes to idle mode after blinking the following message for seven seconds:

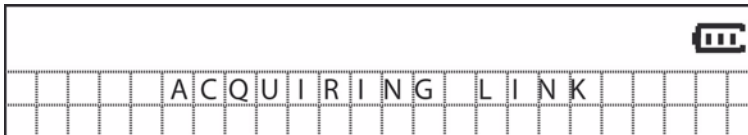

## Out of Range

- ▶ When the handset is in the idle mode, it will show this screen when it cannot find the base station (Out of Range).



- ▶ If the **TALK**, **speaker-icon** or one of the F1-F12 buttons are pressed but the handset cannot establish an RF link with the base station, the handset will sound an error tone and show the Out of Range message.

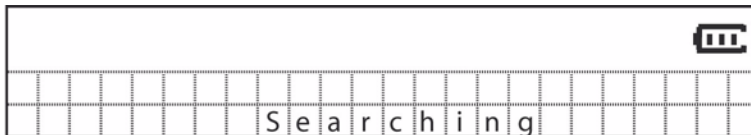

↓ Press **talk**, **speaker** or **F1~F12** key

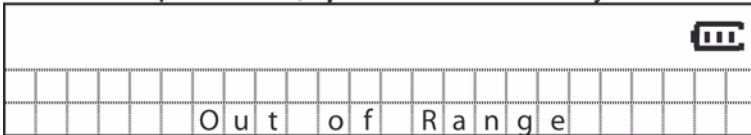

- ▶ While talking, if the handset cannot receive a signal from the base station for approx. five seconds, it goes to idle mode - conversation is dropped - with an error tone. In this case, the LCD shows the message below.

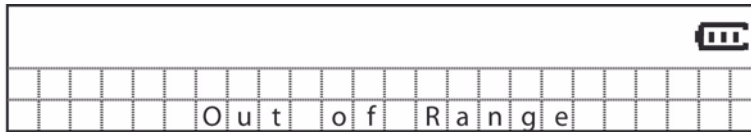

after 5 seconds

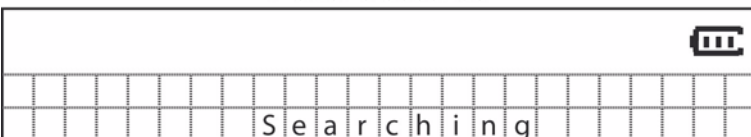

## Low Battery

Your DKT2404-DECT comes equipped with one rechargeable BT1009 battery that provides 16 hours of talk time and seven days standby time (fully charged). The LCD shows the battery according to the remaining capacity.

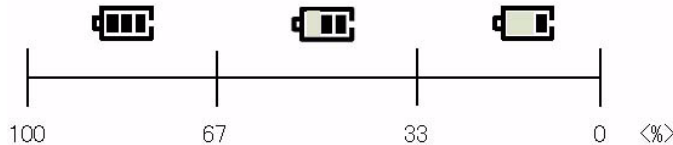

Low battery symptoms are:

- On a call
  - Battery status icon changes to battery low.
  - Handset keeps talk mode and the battery low alert tone is emitted every 30 seconds.
- In standby mode
  - Battery status icon changes to battery low.
  - Charge Battery message blinks on and off on the display.

To restore your battery capacity, return the handset to the charging unit or replace the handset battery with a charged one. After the handset is on the charging unit for one minute the battery icon stops blinking and the battery low tone stops.

For more information on installing and charging the battery, see [Step 7: "Install Handset Battery Pack"](#).

## Mute

- During talk mode, press the **menu/MUTE** button on the front of the handset. The **MUTE** icon displays on the screen and the microphone is dead.
- Press the **menu/MUTE** button again to cancel the mute condition. Finishing the conversation also cancels the mute condition.

### Hands Free

- Press the **speaker-icon** button in either standby mode or during a call. The handset goes to hands-free operation and the speaker icon displays on the screen.
- Press **TALK** to return to return to “non-speaker” (normal) operation.
- Press the **speaker-icon** button (or TALK button twice) to end the call and return to idle.

### Volume Setting

- Volume setting can be changed from Levels 1 to 6 (highest). Talk mode, hands-free mode and headset mode each have volume settings. When the +/- buttons are pressed, the handset immediately goes to volume setting mode, sounding the ringer and displaying the current volume for five seconds. During this time use the +/- buttons to change the volume.

### Ring Volume Setting

When the + (up) button is pressed when the handset is idle, the handset goes to the Ringer Volume setting and displays the current setting. The Ring volume is changed as follows:

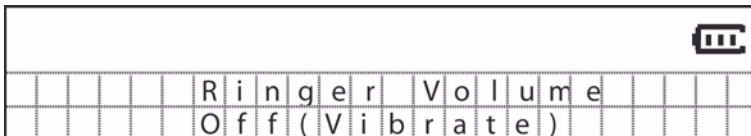

Press the up button to show the next screen

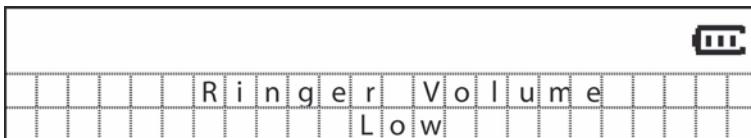

Pressing the up button again shows this screen

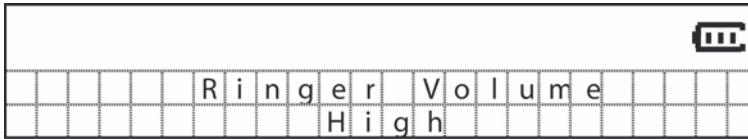

Pressing the up button a third time shows this screen

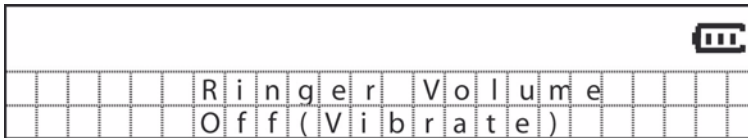

- When the ringer volume is Off (Vibrate), the handset vibrates instead of ringing. If the handset is on the charger and a call comes in, the ringer outputs the low tone instead of vibrating.
- If the ringer mute is on, the handset will output a ringer tone or it will vibrate in Ringer Volume Setting mode.
- Pressing **TALK** or the **speaker-icon** buttons in Ring Volume setting mode cancels the ringer volume setting and the handset goes idle.

## Ringer Mute

- If the - (down) button is pressed and held for two seconds in standby mode or in incoming call mode, the handset sets the Ringer mute on, turns on the Ringer mute icon and stops the ringer. Press and hold the - button for two seconds to turn the Ringer mute off (unmute).
- Any incoming call will blink on the handset.
- The setting will be saved until it is changed.

## Menu Setting Mode

The Menu setting mode can change various settings such as ring type, registration and deregistration.

- Press **TALK** or the **speaker-icon** button in any menu setting mode to cancel the operation and go into idle mode.
- If there is no key operation for one minute, the menu setting cancels and goes to idle mode.
- Select Exit and press the **menu/MUTE** button to go to idle mode.

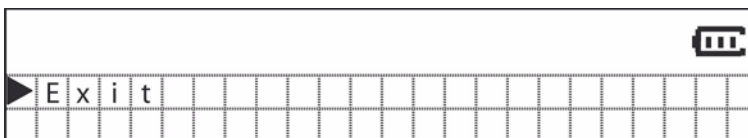

### Change Ringer Type

1. Press the **menu/MUTE** button in idle mode. The LCD shows the menu list.
2. Select Change Ringer Type by the + or - button and press **menu/MUTE**.

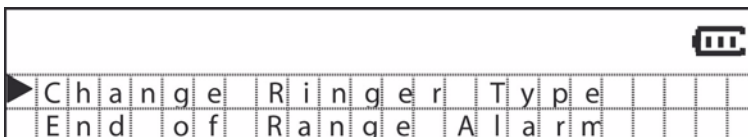

3. The LCD shows tone types and sounds each one as the + or - button is pressed.

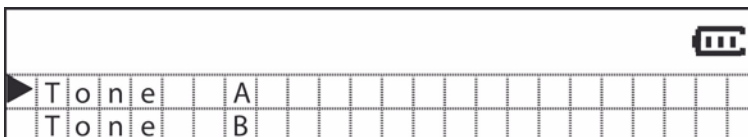

4. Press the **menu/MUTE** button at the desired tone.

5. The handset will emit a confirmation tone and show Saved on the LCD and then go to the menu list mode.



## End of Range Alarm

1. Press the **menu/MUTE** button while the handset is in idle mode. The LCD shows the menu list and the handset goes to menu list mode.
2. Select End of Range Alarm using the + or - buttons and press **menu/MUTE**.

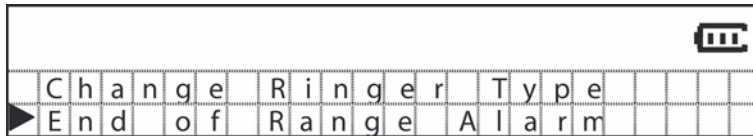

3. The LCD will show On and Off. Select either one by the + or - button and press menu/MUTE.

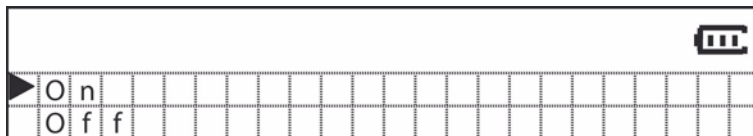

4. The handset will emit a confirmation tone and show Saved on the LCD and then go to the menu list mode.



## Registration

1. Press the **menu/MUTE** button while idle. The LCD shows the menu list mode. Press the - button to go to the next screen.
2. Select Register using the + or - button and press **menu/MUTE**.

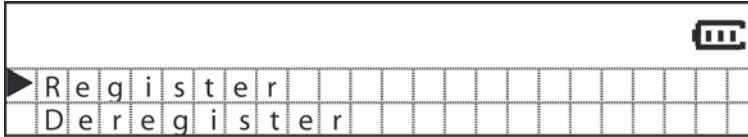

3. The LCD shows the message below. Select No or Yes by the + or - buttons and press **menu/MUTE**. If you choose No the handset goes to the menu list mode.

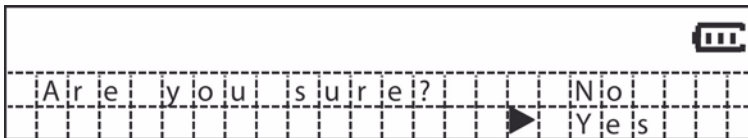

4. If you choose Yes, the LCD shows the message below.

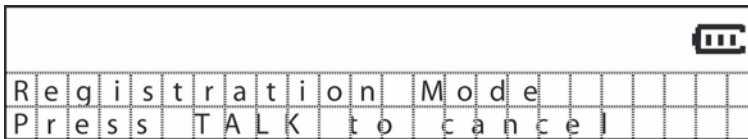

5. On the base station, press the button (if your base station has two buttons, this is the left button as you are facing the front of the base station) and hold for 3 seconds. The POWER light will blink and you have 1 minute to perform the next step.
6. Enter the base PIN (default base PIN is 1234).

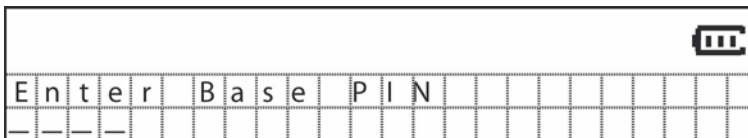

To clear the last digit, press the - button. To clear all the digits hold the - button down for 2 seconds. After all digits are gone, press the - button. The handset goes to the menu list mode.

- The handset is registered to the base station after the LCD shows the message below and goes idle.

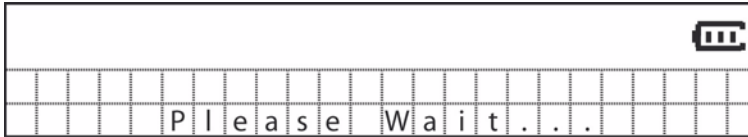

## Deregistration

- Press the **menu/MUTE** button in idle mode. The LCD shows the menu list and the handset goes to menu list mode.
- Select Deregister by pressing the + or - button and pressing **menu/MUTE**.

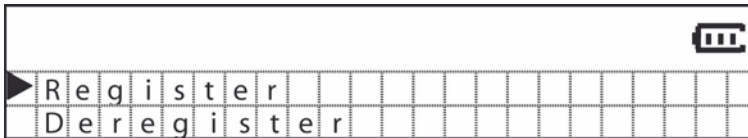

- The LCD shows the message below. Select No or Yes by pressing the + or - button and pressing **menu/MUTE**.

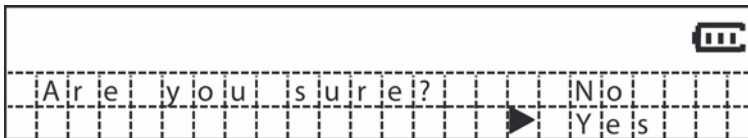

- Press the **menu/MUTE** button when the pointer indicates No and the handset returns to idle.
- The handset will be deregistered from the base station. The handset emits a confirmation tone, shows the message below and goes to the menu list mode.



## Base Registration PIN

1. Press the **menu/MUTE** button while in standby mode. The LCD shows the menu list and the handset goes into menu list mode.
2. Use + or - button to go through the screens to the Base Registration PIN screen as shown below and press the **menu/MUTE** button.

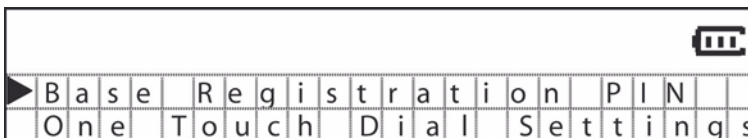

3. The LCD shows base registration PIN. In the example below, 1234 is the base PIN default.



To change the PIN: To back up one digit, press the - button; hold the - button to return to the first digit and enter the new PIN.

4. Press the **menu/MUTE** button to save the Base PIN. The handset emits a confirmation tone, displays the saved message and goes to menu list mode.

## Base Key Option (Option)

When the handset is in base key option mode, the F11 and F12 buttons on the handset are used as base buttons one and two (your base unit may have just one button). When both the Base Key option and One Touch Dialing options are enabled, the One Touch Dial buttons are F9 and F10.

# One Touch Dialing

Buttons F9 - F12 can be as One Touch Dial buttons.

## Dial Store Mode

1. Press the **menu/MUTE** button in standby mode. The LCD shows the menu list.
2. Select One Touch Dial Setting using the + or - buttons and press **menu/MUTE**.

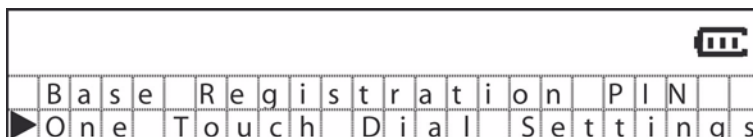

3. The handset goes to Dial Store mode and shows One Touch Dial button name and the number that is stored. Select One Touch Dial 1-4 using the + or - buttons.

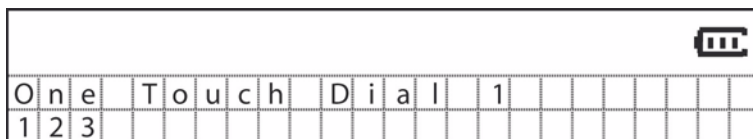

If a number is not stored, the second line of the LCD is blank.

When both the Base Key Option and One Touch Option are enabled, the One Touch Dial 3 and 4 options disappear.

4. Press **menu/MUTE**. The LCD shows the edit display.

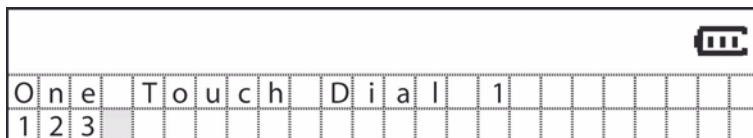

## Operation & Setup

### One Touch Dialing

5. If no number is stored, the LCD shows the following:

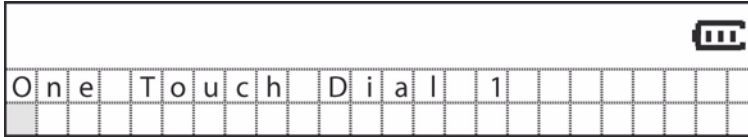

- If, for instance, a 24 digit number is stored, the LCD displays:

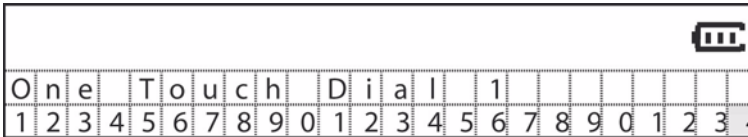

6. Use the keypad to enter a number. To delete the last digit, press the - button. To delete all digits, press and hold the - button.

One Touch Dialing can store up to 24 digits. If keypad button is pressed when there are already 24 digits entered, the handset emits an error tone.

7. Press the **menu/MUTE** button. The handset emits the confirmation tone, the LCD shows the message below and the handset goes to the One Touch Dial List mode.



To delete the registered number in the One Touch Dial menu, press **menu/MUTE** after deleting all the digits at Step 5.

If **TALK** or the **speaker-icon** button is pressed during a One Touch Dial number entry, the handset aborts the store operation and the handset goes to idle.

## Dial Out

1. Press the **TALK** button on the handset (the current volume shows for 2 seconds) to get dial tone.
2. Press a One Touch Dial button - the number registered will be shown and the digits sent to the Strata CIX.
  - An error tone is emitted when the handset does not have a One Touch button.
  - During a conversation you can send a One Touch dial number at any time. When the One Touch number is sent, the current dial display disappears.
  - When a function button is pressed while the digits are being sent, the dial output is canceled.

## F9~F12 Feature Buttons

The **F9~F12** buttons on your cordless telephone can be assigned as one-touch dial buttons and were preassigned upon system installation. If you are not using these buttons for the assigned features, you can invoke features with access codes. See [Step 4: "Feature Access Codes"](#) for access code sequences that match your Toshiba telephone system.

## Place a Call on Hold

- Press the **Hold** button. HOLD displays on the LCD.
- **To resume the call**
  - Press the flashing function button.

## Transfer a Call

- Press **Cnf/Trn**. The dialed numbers saved in transfer memory is shown on the display after two seconds. When the receiving party answers, press **Cnf/Trn** to complete the transfer.

# Redial a Number

- Press **Talk** and then **Redial**. The last number called is redialed.

**Note** If you are using the Strata CTX system, the **Redial** button works only with the last dialed number that was answered. If you dial a number and receive no answer, the **Redial** button will not use that number as the last one dialed.

# Conference a Call

- Press **Cnf/Trn**. The dialed numbers saved in conference memory is shown on the display after two seconds. When the other party answers, press **Cnf/Trn** to have a three-way conversation.

# Switch a Call to Your Cordless Digital Telephone

1. Press **Hold** on the desktop telephone, then press **Talk** on the DKT2404-DECT handset.
2. Press the flashing Line LED. The call is now transferred to the DKT2404-DECT handset, and the desktop telephone is disconnected.

# Switch a Call to the Desk Telephone

1. Press **Hold** on the DKT2404-DECT handset.
2. Pick up the desktop telephone and press the flashing Line LED. The cordless telephone is disconnected.

## Feature Access Codes

This chapter gives you all of the cordless digital telephone features in alphabetical order. Your cordless digital telephone provides many of the same features as a 2000-series corded digital telephone.

In addition to the **Msg**, **Hold**, **Cnf/Trn** and **Redial** functions, your cordless digital telephone's **F1~F4** buttons perform the same way as the first four buttons on your 3000- or 2000-series digital telephone. They are assigned during system installation. See your System Administrator for the features that have been assigned.

If you are not using these buttons for the assigned features, you can invoke the features with access codes. Please see Table 2 below for access code sequences that match your Toshiba telephone system.

For detailed feature descriptions, see the *Strata CTX DKT/IPT Telephone User Guide*.

**Table 2. Feature Access Codes**

Feature	Feature Access Code Sequences
<b>Account Code</b>	Cnf/Trn + #46 + Account code digits
<b>Attendant Console</b>	0
<b>Automatic Busy Redial - On</b>	#441
<b>Automatic Busy Redial - Off</b>	#442
<b>Automatic Callback Cancel</b>	#431
<b>Background Music</b>	
Telephone Speaker On	Ext. button + #490 + source number + #
Telephone Speaker Off	Ext. button + #491

## Feature Access Codes

### Feature Access Codes

**Table 2. Feature Access Codes** (continued)

Feature	Feature Access Code Sequences
External Speaker On	Ext. button + #492 + source number + #
External Speaker Off	Ext. button + #493
<b>Call Forward - Refer to Table 3</b>	
<b>Call Park</b>	
Activate	Cnf/Trn + #33 + Orbit Number (or #33#)
Retrieve	Ext. button + #32 + Orbit Number (or #32#)
System Orbits	7000-7019
<b>Call Pickup</b>	
Incoming - Group Pickup	Ext. button + #5#34
Incoming - Directed Extension Pickup	Ext. button + #5#5 + Ext. Number to be picked up
Incoming - Directed Group Pickup	Ext. button + #5#32 + Group Number to be picked up
Incoming - Directed Extension Pickup	Ext. button + #5#22 + Ext. Number
Directed DN Pickup of either Ringing or Held Call	Ext. button + #5#6 + Ext. Number
On hold - Local Retrieve	Ext. button + #5#71
On hold - Remote Retrieve	Ext. button + #5#72 + Remote Ext. No.
On hold - Outside line Retrieve	Ext. button + #5#73 + Line on hold
On hold - Directed Extension Retrieve	Ext. button + #5#74 + Ext. No. on hold
<b>Conferencing - Three Way</b>	#494
<b>Dialing</b>	
Dial *	441
Dial #	440
<b>DISA Security Code - Change</b>	#658 + old Security Code (1-15 digits) + # + new Security Code (1-15 digits) + #

**Table 2. Feature Access Codes** *(continued)*

<b>Feature</b>	<b>Feature Access Code Sequences</b>
<b>Do Not Disturb</b>	
Local - On	#6091
Local - Off	#6092
Remote - On	#6191 + ext. no. + Pass Code Number + #
Remote - Off	#6192 + ext. no. + Pass Code Number + #
<b>Door Lock Control</b>	#12 + Door Lock Number
<b>Door Phone Calling</b>	#15 + Door Phone No. (01~24, depending on system size)
<b>Emergency Call</b>	#911
<b>Flash - Short</b>	#450
<b>Flash - Long</b>	#451
<b>LCD Language (Change)</b>	#495 + Language No.
<b>LCR (Outgoing Call)</b>	9
<b>Message Waiting (MW)</b>	
Release a received MW	#409
Retrieve a received MW	#408
Activate MW at another Station without Ringing	#63 + Ext. no.
Cancel MW at another Station without Ringing	#64 + Ext. no.
<b>Messaging - Advisory</b>	
Advisory Message - Activation	#411 + Message No.
Advisory Message - Cancellation	#412
<b>Network Access Code (Private Network)</b>	8 + Private Network No.
<b>Night Ring Answer</b>	#5#39
<b>Off-hook Call Announce (Manual Mode)</b>	Voice First: 2; Tone First: 1, 21, or 12
<b>Override</b>	

## Feature Access Codes

### Feature Access Codes

**Table 2. Feature Access Codes** (continued)

Feature	Feature Access Code Sequences
Busy, Do Not Disturb	2
Executive	3
<b>Paging</b>	
Page All Groups	#30
Page Individual Groups	#31 + Group Number
Emergency Page - Individual Group	#38 + Group Number
Emergency Page - All Groups	#37
Answer for External Group Page	#5#36 + Zone Number
<b>Repeat Last Number Dialed</b>	*0
<b>Speed Dial Register</b>	#66
Station (00~99)	*1 + Index Number (00~99)
System	*2 + Index Number (000~099)
	*3 + Index Number (100~199)
	*4 + Index Number (200~299)
	*5 + Index Number (300~399)
	*6 + Index Number (400~499)
	*7 + Index Number (500~599)
	*8 + Index Number (600~699)
	*9 + Index Number (700~799)
<b>Start Application</b>	#18
<b>Substitution of Dial “#”</b>	440
<b>Substitution of Dial “*”</b>	441
<b>Travelling Class Override</b>	
Enter Code	#471
Change Code	#69 + Index Number + old Code + # + new Code + #
<b>User Programming Mode</b>	#9876

**Table 2. Feature Access Codes** *(continued)*

Feature	Feature Access Code Sequences
<b>Voice Mail (VM)</b>	
Direct Transfer to Voice Mail	#407 + Ext. Number
<b>Volume Control - Beep</b>	#6101
<b>Volume Control - Ringing</b>	#6102

## Call Forward Codes

**Table 3. Call Forward Procedure**

Feature	Button Sequence
<b>Call Forward Any Call - Internal and Incoming Line Calls:</b>	
Forwards any call, whether an internal call or incoming line call.	
All Calls to an ext.	Press ext. button + #6011 (tone) + dial the dest. ext. no. (tone)
All Calls to outside telephone no.	Press ext. button + #6011 (tone) + outside line access code + dest. telephone no. + # (tone)
Busy to an ext.	Press ext. button + #6021 (tone) + dial the dest. ext. no. (tone)
Busy to outside telephone no.	Press ext. button + #6021 (tone) + outside line access code + dest. telephone no. + # (tone)
No Answer to an ext.	Press ext. button + #6031 (tone) + dial the dest. ext. no. + timer (08~60) (tone)
No Answer to outside telephone no.	Press ext. button + #6031 (tone) + outside line access code + dest. telephone no. + # (tone) + timer (08~60) (tone)
Busy No Answer to an ext.	Press ext. button + #6041 + dial the dest. ext. no. (tone) + timer (08~60) (tone)
Busy No Answer to outside telephone no.	Press ext. button + #6041 + outside line access code + dest. telephone no. + # + timer (08~60) (tone)
Cancel	Press ext. button + #6051 (tone)

## Feature Access Codes

### Call Forward Codes

**Table 3. Call Forward Procedure** *(continued)*

Feature	Button Sequence
<b>Call Forward - Incoming Line Calls:</b> Forward incoming line calls only.	
All Calls to an ext.	Press ext. button + #6013 (tone) + dial the dest. ext. no. (tone)
All Calls to outside telephone no.	Press ext. button + #6013 (tone) + outside line access code + dest. telephone no. + # (tone)
Busy to an ext.	Press ext. button + #6023 (tone) + dial the dest. ext. no. (tone)
Busy to outside telephone no.	Press ext. button + #6023 (tone) + outside line access code + dest. telephone no. + # (tone)
No Answer to an ext.	Press ext. button + #6033 + dial the dest. ext. no. (tone) + timer (08~60)
No Answer to outside telephone no.	Press ext. button + #6033 + outside line access code + dest. telephone no. + # (tone) + timer (08~60)
Busy No Answer to an ext.	Press ext. button + #6043 + dial the dest. ext. no. (tone) + timer (08~60) (tone)
Busy No Answer to outside telephone no.	Press ext. button + #6043 + outside line access code + dest. telephone no. + # (tone) + timer (08~60) (tone)
Cancel	Press ext. button + #6053 (tone)
<b>Call Forward Any Call - Set for Another Station:</b> Enables you to set call forwarding for another telephone within your telephone system. You will need the other telephone's CF pass code in order to do this. CF Pass Codes are created in system programming.	
All Calls to an ext.	Press ext. button + #6012 (tone) + dial the other telephone's ext. no. + enter other telephone's CF pass code + # + dest. telephone no. (tone)
All Calls to outside telephone no.	Press ext. button + #6012 (tone) + dial the other telephone's ext. no. + enter other telephone's CF pass code + # + outside line access code + dest. telephone no. + # (tone)
Busy to an ext.	Press ext. button + #6022 (tone) + dial the other telephone's ext. no. + enter other telephone's CF pass code + # + dest. telephone no. (tone)
Busy to outside telephone no.	Press ext. button + #6022 (tone) + dial the other telephone's ext. no. + enter other telephone's CF pass code + # + outside line access code + dest. telephone no. + # (tone)

**Table 3. Call Forward Procedure** *(continued)*

<b>Feature</b>	<b>Button Sequence</b>
No Answer to an ext.	Press ext. button + #6032 (tone) + dial the other telephone's ext. no. + enter other telephone's CF pass code (tone) + # + dest. telephone no. (tone) + timer (08~60) (tone)
No Answer to outside telephone no.	Press ext. button + #6032 (tone) + dial the other telephone's ext. no. + enter other telephone's CF pass code (tone) + # + outside line access code + dest. telephone no. + # (tone) + timer (08~60) (tone)
Busy No Answer to an ext.	Press ext. button + #6042 + dial the other telephone's ext. no. + enter other telephone's CF pass code + # (tone) + dest. telephone no. (tone) + timer (08~60) (tone)
Busy No Answer to outside telephone no.	Press ext. button + #6042 + dial the other telephone's ext. no. + enter other telephone's CF pass code + # (tone) + outside line access code + dest. telephone no. + # (tone) + timer (08~60) (tone)
Cancel	Press ext. button + #6052 (tone) + dial the other telephone's ext. no. + enter other telephone's CF pass code + # (tone)

## Feature Access Codes

### Call Forward Codes

**Table 3. Call Forward Procedure** *(continued)*

Feature	Button Sequence
<b>Call Forward - Incoming Line Call - Set for Another Station:</b>	
Enables you to set forwarding of incoming line calls for another telephone within your telephone system	
All Calls to an ext.	Press ext. button + #6014 (tone) + dial the other telephone's ext. no. + enter other telephone's CF pass code + # (tone) + dest. telephone no. (tone)
All Calls to outside telephone no.	Press ext. button + #6014 (tone) + dial the other telephone's ext. no. + enter other telephone's CF pass code + # (tone) + outside line access code + dest. telephone no. + # (tone)
Busy to an ext.	Press ext. button + #6024 (tone) + dial the other telephone's ext. no. + enter other telephone's CF pass code + # (tone) + dest. telephone no. (tone)
Busy to outside telephone no.	Press ext. button + #6024 (tone) + dial the other telephone's ext. no. + enter other telephone's CF pass code + # (tone) + outside line access code + dest. telephone no. + # (tone)
No Answer to an ext.	Press ext. button + #6034 (tone) + dial the other telephone's ext. no. + enter other telephone's CF pass code + # (tone) + dest. telephone no. (tone) + timer (08~60)
No Answer to outside telephone no.	Press ext. button + #6034 (tone) + dial the other telephone's ext. no. + enter other telephone's CF pass code + # (tone) + outside line access code + dest. telephone no. + # (tone) + timer (08~60) (tone)
Busy No Answer to an ext.	Press ext. button + #6044 (tone) + dial the other telephone's ext. no. + enter other telephone's CF pass code + # (tone) + dest. telephone no. (tone) + timer (08~60) (tone)
Busy No Answer to outside telephone no.	Press ext. button + #6044 (tone) + dial the other telephone's ext. no. + enter other telephone's CF pass code + # (tone) + outside line access code + dest. telephone no. + # (tone) + timer (08~60) (tone)
Cancel	Press ext. button + #6054 (tone) + dial the other telephone's ext. no. + enter other telephone's CF pass code + # (tone)
<b>Change Call Forward Pass Code:</b>	
Your telephone must be enabled in programming to have the ability to change pass codes.	
Change Pass Code	Press ext. button + #670 (tone) + dial the dest. ext. no. (tone) + old pass code + # (tone) + new pass code (tone) + #

# Troubleshooting and Specifications

# 5

## Troubleshooting

If your cordless telephone is not performing to your expectations, try the suggestions in Table 4. If you are still unable to resolve the problem, contact your telephone System Administrator.

**Important!** Do not attempt to service this unit yourself. All service must be done by qualified service personnel.

**Table 4. Troubleshooting Suggestions**

Condition	Suggestion
CHARGE LED does not light when handset is placed on charging unit.	<ul style="list-style-type: none"><li>• Make sure the AC adapter is plugged into the charging unit and wall outlet.</li><li>• Make sure handset is properly seated in charging unit.</li><li>• Make sure the battery pack is properly placed in the handset.</li><li>• Make sure that the charging contacts on the handset and charging unit are clean.</li></ul>
Conversation is interrupted frequently.	<ul style="list-style-type: none"><li>• Make sure the base unit is positioned correctly.</li><li>• Move closer to the base unit.</li><li>• Check for low battery warning.</li></ul>
Warning tone and Out of Range message.	<ul style="list-style-type: none"><li>• Move closer to the base unit.</li></ul>

**Table 4. Troubleshooting Suggestions** (continued)

Condition	Suggestion
Handset doesn't ring.	<ul style="list-style-type: none"><li>• The battery pack may be weak. Charge the battery pack for five~six hours.</li><li>• Make sure the base unit is positioned correctly.</li><li>• The handset may be too far away from the base unit.</li><li>• The ringer may be set to Off.</li><li>• Make sure the AC adapter is plugged into the base unit and wall outlet.</li></ul>

## DKT Mode

When a Toshiba DKT is connected to the Base of a cordless handset, the cordless telephone LCD will display “DKT Mode” whenever the digital telephone is in use.

**Important!** If the cordless telephone is in a stand-alone configuration and its LCD displays “DKT Mode” the Off-hook Preference assignment in Program 204-13 is probably not set correctly; the Off-hook Preference of all cordless telephones must be set to “Ringing” or “No Preference.”

## Cleaning Charging Unit Contacts

To maintain a good charge, it is important to clean all charging contacts on the handset, spare battery pack and charging unit about once a month (shown right). Use a pencil eraser or a soft dry cloth. Do not use any liquids or solvents.

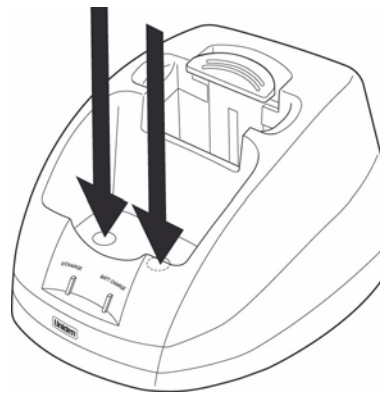

## Charging Spare Battery Packs

The charging unit of your cordless telephone is equipped to charge the spare battery pack with or without the handset in the front slot.

1. Slide the spare battery pack into the second slot in the charging unit until the retaining clip snaps over the top of the pack.
2. Make sure the **battery** indicator lights. If the indicator doesn't light, check to see that the AC adapter is plugged in, and that the battery pack is making good contact with the unit's charging contacts.

**Note** Charge the battery pack without interruption for 12~15 hours.

3. When charging is complete, press out on the latch and remove the battery pack for use. If you don't need the battery pack immediately, leave it in the charging compartment. It will not overcharge.

## Range and Performance

Ranges of 300 to 400 feet are possible depending on the building structure in which it is used. The range is affected by the operating environment and base station placement, and can be impacted by factors including metal walls, walls with metal studs, office partitions, cabinets, other RF sources in the area, and nearby equipment. For optimum range and performance from your handset, try the following:

- Place the base units at least three to six feet away from the DKT; three feet from metal structures; and six feet from computers, fax machines or other electronic equipment.
- Place the base unit as high as possible in the room
- Use an AC outlet not associated with computer or electromagnetic equipment.
- Wherever possible, put the base unit in the middle of the coverage area.

## Radio Interference

Radio interference occasionally interrupts conversations, which does not mean that your unit is defective. Move to a different location while you are talking. If the interference continues, move the base unit. If there is still interference, contact your System Administrator.

## Telephone Line Problems

The FCC and IC have granted the telephone company the right to disconnect service in the event that your telephone causes problems on the telephone line. Also, the telephone company may make changes in facilities and services which may affect the operation of your unit. However, your telephone company must give adequate notice in writing prior to such actions to allow you time for making necessary arrangements to continue uninterrupted service.

If you are having trouble with your telephone service, you must first disconnect your telephone to determine if it is the cause of your problem. If you determine that it is the cause, you must leave it disconnected until the trouble has been corrected.

## Privacy

Cordless telephones are radio devices. Communications between the handset and base unit of your cordless telephone are accomplished by means of radio waves which are broadcast over the open airways. Because of the inherent physical properties of radio waves, your communications can be received by radio receiving devices other than your own cordless telephone unit. Consequently, any communications using your cordless telephone may not be private.

# Specifications

For frequencies, power requirements, weight and size specifications, see Table 5.

**Table 5. Specifications**

<b>General</b>	
Frequency Control	Phase Lock Loop
Cordless Telephone Technology	DECT 6.0
Operating Temperature	+32° F to + 104°F (0° to 40° C)
Audio Codec	G.726
Net Bit Rate	32kbit/s
Carriers	5 (1,728 kHz spacing) - US
Time Slots	2 x 12 (up/down stream)
Channel Allocation	Dynamic
Average Transmission Power	4mW (100 mW peak) - US
<b>Base Unit</b>	
Receive/Transmit Frequency	1.9 GHz
Power Requirements	10VDC from supplied AC adapter
Size	Width – 8½ inches (216 mm) Depth – 2¼ inches (57.15 mm) Height – 5 inches (127 mm)
Weight	Approximately 15.4 oz. (0.44 kg)
<b>Handset</b>	
Receive/Transmit Frequency	1.9 GHz
Power Requirements	NI-MH Battery Pack (BT1009)
Size	Width – 2¼ inches (57.15 mm) Depth – 1 inches (25.4 mm) Height – 6½ inches (165 mm)
Weight	Approximately 8.8 oz. with battery (0.25 kg)
Battery	Capacity – 910 mAh, 2.4 V Talk Mode – 16 hours (typical) Standby Mode – 7 days (typical)

**This is the last page of the document.**